

SCHROEDAHL

we protect your business

Oil and Gas

high-class pump protection



SCHROEDAHL worldwide

Profit from the experience, competence and technical know-how of a leading international supplier of specialty valves.



SCHROEDAHL is a worldwide operating company with decades of experience in development and manufacturing of high-class specialty valves for power stations, industrial plants, as well as for production, transport and refining systems in the oil and gas sectors.

Thanks to the high reliability of the SCHROEDAHL products in combination with consequent customer orientation the company is now a worldwide leader in the area of pump protection systems.

Since its founding in 1962 SCHROEDAHL turns innovations into customer applications – an example is the invention of the Pump Protection Valve by one of the founders of the company, Mr. Wilhelm Odendahl.

With our competence and technical know-how in consulting, project management, delivery, assembly, commissioning, inspection, repair, as well as modification we ensure a high availability of complete systems equipped with SCHROEDAHL valves.



Specialist in the oil and gas segments

We offer durable and reliable pump protection for your installations in oil and gas production and refinery operations.



SCHROEDAHL develops and manufactures high-class Pump Protection Valves for the production (upstream) and refining (downstream) of oil and gas.

These are used on offshore platforms, FPSO (floating production storage offloading) or FSO (floating storage offloading) ships as well as in refineries and chemical plants.

The SCHROEDAHL Pump Protection and Control Valves may be combined with various pump types:

- Crude oil pumps
- LNG, LPG, naphta, ammonia pumps (pumps for fluid gas, fluid gas fuel, benzene, fluid ammonia)
- Process liquid pumps

- Booster pumps
- Seawater injection pumps
- Fire-fighting pumps

As our products are used under the toughest conditions, we manufacture at the highest level of quality.

The complete production and processing is based on the important national and international regulations and standards (EN 1092-1, UUV, TUV, AD, TRD, ASME, as well as ISO 9001 / EN 29001).

Also, we use only high quality materials, for example, carbon steel or duplex, to ensure reliability by durable and efficient functioning.

The SCHROEDAHL Pump Protection Valve

Schroedahl invented the Pump Protection Valve (Automatic Recirculation Valve) and is a worldleader in this segment.

Pump protection valves have the task to ensure the minimum flow through a pump. By doing so, the pump is protected against overheating and cavitation which results in damage. In case the process should require no flow or small quantity of the pumped liquids, the Pump Protection Valve automatically returns the required minimum flow back to the pump via the bypass.

The SCHROEDAHL pump protection valves operate to modulate in proper measure. In case the requirement of the process increases, the flow

returned via the bypass is automatically reduced – and this is also reversible. This increases the efficiency of the complete system and optimises the economy of operation during medium process requirements at the same time. The pump protection is only operated via the internal valve technology. Independent of the pressure, it measures which flow the processes require – accordingly, the flow returned via the bypass is automatically adjusted.



Convincing quality in the whole range

Modern technology, extreme durability and clear cost advantages – you can rely on the special class of SCHROEDAHL Pump Protection Valves.



Pump Protection Valves are, in most cases, superior to conventional control valves. As they are flow dependent and only mechanically operated, they require fewer components in total.

In contrast to a Control Valve, no actuator, flowmeter or control unit are needed – only a valve is required!

This makes the SCHROEDAHL high-tec Pump Protection Valves clearly less susceptible to faults and are almost maintenance free. Also the total weight is reduced, which is of significant importance for offshore or FPSO applications.

A further distinguishing advantage: SCHROEDAHL Pump Protection Valves are remarkably economic in all areas – procurement, commissioning, maintenance and wear. The purchase price alone is around two thirds lower than a Control Valve!

During installation the Pump Protection Valve is easily assembled on the outlet of the pump – then it is ready for use! These are all advantages, which should be considered for use in the total concept of your plant.

The advantages of Pump Protection Valves at a glance:

- More economic to purchase, to commission, to service and therefore less wear
- High economical operation due to modulating control of the bypass flow
- Strictly mechanical, flow operated, power independent operation
- Only one valve without additional components – due to this, less susceptible to breakdowns and high wear
- Non-return valve and bypass connection are already integrated in the valve
- Almost maintenance free

The SCHROEDAHL Pump Protection Valves

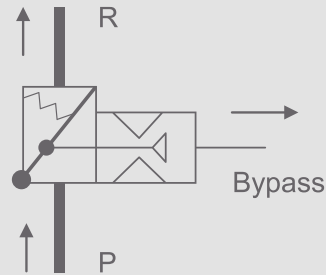

SUL

- Cost economic design with reliable operation for the low pressure range
- Casted housing in CS and SS material
- Pressure classes PN 150 lbs to PN 300 lbs. Size DN 1" to DN 10"
- High flows via the bypass
- For differential pressures (ΔP bypass) up to 40 bar

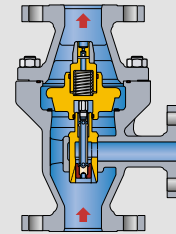

TDL

- Forged housings with large range of standard materials from CS, SS to duplex materials, special materials upon request
- Pressure classes PN 150 lbs to PN 600 lbs. Size DN 1" to DN 20"
- Non-return valve in bypass
- For differential pressures (ΔP bypass) up to 40 bar
- Venturi-ring operated main non-return valve for difficult conditions

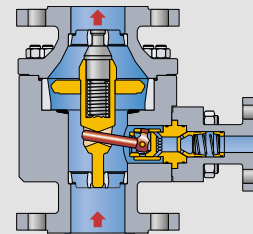

TDM

- High pressure design with multiple stage bypass system
- Forged housing with large range of standard materials as with the TDL valve, special materials upon request
- Pressure classes PN 300 lbs to PN 1500 lbs. Size DN 1" to DN 20"
- Non-return function in the bypass
- For differential pressures (ΔP bypass) up to 230 bar

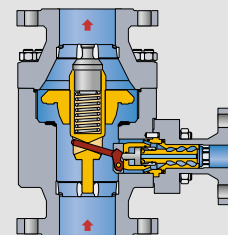

MRM / MRK

- Absolute high pressure design with multiple stage bypass system
- For differential pressures (ΔP bypass) up to 500 bar/ 7250 psi
- Forged housing with large range of standard materials as with the TD valves, special materials upon request
- Pressure classes PN 1500 lbs to PN 4500 lbs. Size DN 1" to DN 16"
- For offshore and other high pressure applications

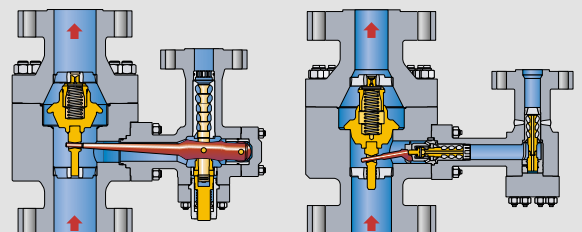

For detailed information please use the specific product catalogues.

Pump Protection Valve project example



◀ In the late 1990s SCHROEDAHL received the order for the supply of two Pump Protection Valves for the **North Sea platform Visund** in norwegian waters.

The project, operated by Norsk Hydro, is situated approximately 140 km west of Sogne Fjord in the North Sea and connects 4 oil reservoirs at a depth of 335 m.

Since 2002 the seawater injection system for the oil and gas production systems, with the two seawater injection pumps, are protected by SCHROEDAHL valves.

In year 2005 we have supplied three very special high pressure pump protection valves for the **AKPO / Nigeria** project.

AKPO project is the development of oil and gas field located at 150 km and 1400 meters deep-sea offshore Nigeria, West Africa.



Visund Project

The two high pressure valves of type **MRM150UHWV-SD** are sized DN 8" (DN 200) with the pressure class PN 2500 lbs (PN 400) and they are manufactured out of special seawater resistant 22% chrome duplex materials.

The valves are designed for a bypass flow of 122 m³/h at a pump head of 4000 m, and a main flow of 490 m³/h.

AKPO Project

The tree valves **MRM160UVWV-SD** are sized DN 10" (DN 250) with the pressure class PN 2500 lbs (PN 400) and they are manufactured out of super duplex material with 25% chrome content.

The valve design is based on recirculation flow of 570 m³/h at a pressure head of about 2500 m.

The SCHROEDAHL Control Valve

Profit from our experience and technical know-how – SCHROEDAHL has developed and manufactured Control Valves since 1962.

Control Valves are the conventional type of pump protection. The complete system consists of the actual Control Valve with mounted actuator, a flow-meter in the main line of the pump, as well as a control unit.

During pump operation the flow is continuously measured, the results are then transferred to the control unit. In case the required minimum flow of the pump is lower than defined, the control unit opens the Control Valve and supplies the minimum flow of the medium – such as oil, gas, seawater, chemicals – to the pump. Damage of the pump due to cavitation or overheating is avoided.

SCHROEDAHL offers fully developed and worldwide proven Control Valve systems, optimally pre-set according to your conditions.

Our experienced technicians and engineers will be pleased to do the fine tuning and setting of the system and components for commissioning on site.

Of course, we're also there for you for future inspections and maintenance of the control system (i.e. to check the settings).

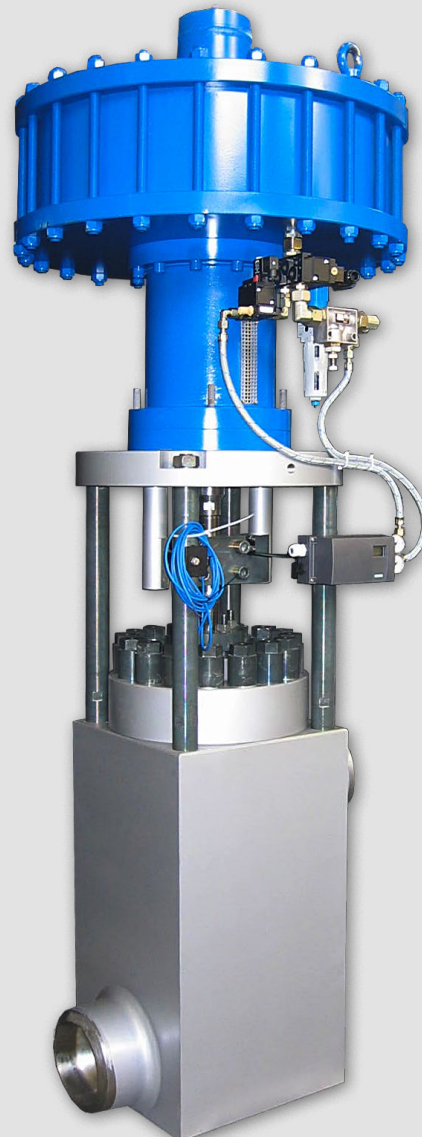
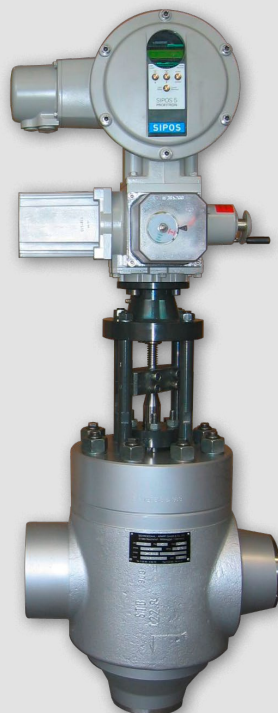

Well-proven top quality

For special applications, not covered by the SCHROEDAHL Pump Protection Valves, we recommend our Control Valve type ACA.

SCHROEDAHL Control Valves are high quality products; the quality and use of which are also suitable for tough conditions.

By continuous development based on years of experience as well as extensive technical competence the SCHROEDAHL control systems are well proven and optimised in detail. High reliability and a simultaneous long lifetime pays off particularly in special cases where the modern Pump Protection Valves are not an alternative.

For the pump protection in the oil and gas sectors we offer our Control Valve ACA, which can be designed for simple on/off, as well as for modulating operation. Advantages of the ACA are the low noise operation, as well as the minimal wear by consequently using high grade materials. The easy assembly of this Control Valve makes inspection especially service friendly.

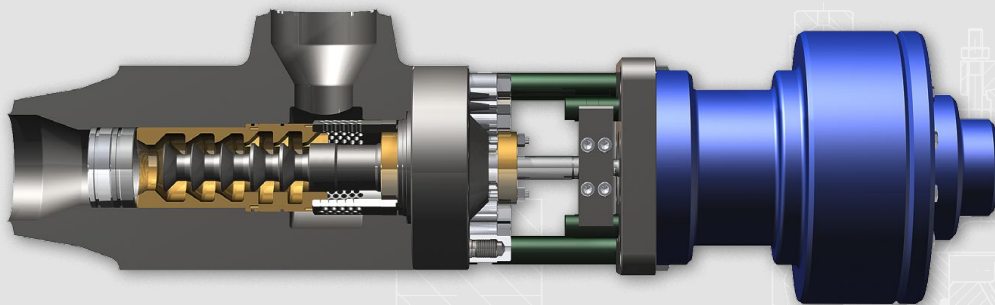

Technical data of the Control Valve

Type ACA

- Forged housing
- Pressure classes PN 150 lbs to PN 4500 lbs. Standard size DN 1" to DN 8"
- Combinable with most common actuators
- Angle and Z type body

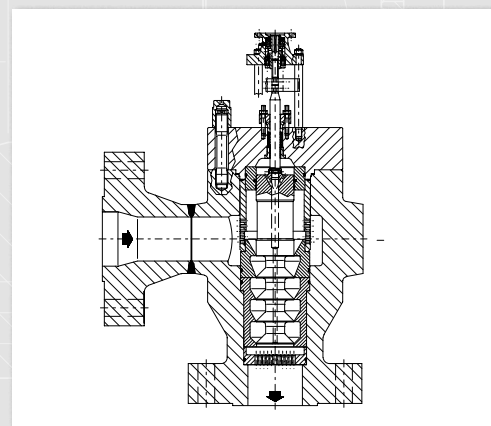

Control Valve project example



In the year 2004 SCHROEDAHL received the order for the supply of six control valves for pump protection on the **P-52 Platform** in Brazil.

The project is operated by Petrobras/Brazil and is located in the Campos Basin at the Roncador oil reservoir at a depth of 1900 m. The production target in 2006 was approx. 180,000 barrels of oil and approx. 9 million cubic metres of gas daily. The supplied valves are for the protection of the crude oil pumps.

The pneumatic operated control valves of type

ACAP 1053 ZU2
ACAP 1075 ZU2

are of nominal size DN 3" (DN 80), the pressure classes are PN # 300 lbs (PN 63) and PN # 900 lbs (PN 160). The multiple stage internals are made out of duplex material, which is specially resistant to seawater.

The valves are designed for a pump pressures at minimum flow operation of 35.7 and respectively 116.7 bar at a minimum flow of 113 m³/h.

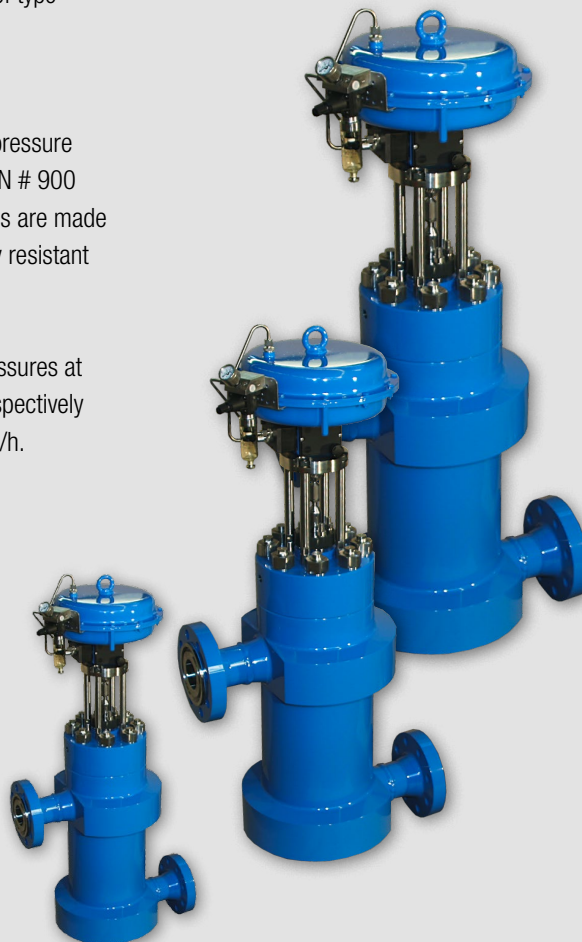

References



SCHROEDAHL

we protect your business

SCHROEDAHL-ARAPP

Spezialarmaturen GmbH & Co. KG

Schoenenbacher Str. 4
51580 Reichshof-Mittelagger
GERMANY

Phone +49 2265 9927-0

Fax +49 2265 9927-927

www.schroedahl.com

info@schroedahl.com

Schroedahl International Corporation

2400 Augusta Dr. Suite 285

Houston, Texas 77057

United States of America

Phone +1 713 9758351

Fax +1 713 7800421

sic@schroedahl.com